

NEVADA

INSTALLATION & INSTRUCTIONS MANUAL

veito

IMPORTANT SAFETY INSTRUCTIONS

Warning!

When using electrical appliances, basic safety precautions should always be followed to reduce the risk of fire, electric shock, and injury to persons, including the following:

This manual contains important product safety information. Ensure that you read all provided instructions before installing or using this heater.

The manufacturer is not responsible for any damage that may result from inappropriate use. The heater must be used in a responsible manner and all warnings and instructions included in this manual must be followed.

This heater is hot when in use. To avoid burns, do not let bare skin touch hot surfaces. Keep combustible materials, such as furniture, pillows, bedding, papers, clothes, etc. and curtains at least 150cm from the front of the heater and keep them away from the sides and rear.

Extreme caution is necessary when any heater is used by or near children or invalids and whenever the heater is left operating and unattended.

Do not operate any heater after it malfunctions. Disconnect power at service panel and have heater inspected by a reputable electrician before reusing.

To disconnect heater, turn controls to off, and turn off power to heater circuit at main disconnect panel (or operate internal disconnect switch if provided).

Do not insert or allow fingers or foreign objects to enter any ventilation or exhaust opening as this may cause an electric shock or fire, or damage the heater.

To prevent a possible fire, do not block air intakes or exhaust in any manner.

A heater has hot and arcing or sparking parts inside. Do not use it in areas where gasoline, paint, or flammable vapors or liquids are used or stored.

Use this heater only as described in this manual. Any other use, not recommended by the manufacturer, may cause fire, electric shock or injury to persons.

Incorrect installation or alterations to the heater, as well as failure to adhere to the warnings and instructions contained within this manual, may cause property damage, severe personal injury, or death. Never attempt to alter the product in any way.

Keep away from the heater when it is in use. Failure to do so could result in clothing catching fire and/or severe personal injury.

This appliance is not intended for use by persons (including children) with reduced physical, sensory or mental capabilities, or lack of experience and knowledge, unless they have been given supervision or instruction concerning use of the appliance by a person responsible for their safety.

Children should be supervised to ensure that they do not play with the appliance.

Ensure that all packaging material is kept out of reach of children.

Children and vulnerable people should be alerted to the hazards of high surface temperatures and should stay away to avoid burns, clothing ignition, or other serious personal injury.

Always disconnect the heater from the electricity supply and allow adequate time for it to cool to room temperature before adjusting the position or attempting to work on it.

Do not touch any part of the heater or plug with wet or moist hands.

Do not cover the heater.

Installation must be carried out by a qualified and licenced person only.

After unpacking, make sure the appliance shows no signs of visible damage or tampering. If the appliance appears damaged, contact the place of purchase for assistance.

This heater must only be used on a 220-240V AC single phase electricity supply.

Remove packaging and any transit protection before installation.

The installer is to ensure that the requirements of the local authority, local electrical installation code, municipal building codes, and any other relevant statutory regulations are carried out.

Do not run the power cord under carpeting. Do not cover with throw rugs, runners, etc. Arrange the cord away from all traffic areas and where people will not trip over it.

Keep the cable away from sharp edges during handling and installation.

Do not allow the supply cord to sit or hang in front of the heater while in use and keep it away from the body of the heater which will get hot during operation.

Do not use or install the heater in bathrooms, laundry areas, or similar indoor locations. Never place the heater near a bathtub or other water container. Do not place switches or controls within reach of a person in a bathtub, shower, or swimming pool.

Do not locate the heater immediately above or below a fixed socket outlet or connection box. This is because the heat radiated from the appliance may damage the electricity outlet or plug.

This heater must be grounded. Connect to properly grounded outlets only.

Ensure both plug and socket is clean and free from dust when using.

To disconnect the heater from the power supply, grip the plug and pull from the power socket. Never pull by the cord.

Always plug directly into a wall socket. Never use with an extension cable as overloading may result in the cable overheating and catching fire.

If there is a loose fit between the plug and the socket or the plug becomes very hot, the socket may need to be replaced. Check with a qualified electrician to replace the socket.

For installation use only the supplied accessories or original accessories approved by the manufacturer.

Repair or service must be carried out by a qualified and licenced person only.

If the appliance has not been used, or will not be used for a long period of time, disconnect the power supply.

Regularly check the heater for damage. Do not use the heater if the heating element is cracked or broken. If damage to the appliance is suspected, discontinue use immediately and contact the supplier or qualified person to repair.

Regularly inspect the power cord and plug for wear or damage and do not operate the heater with a damaged cord, plug or loose socket or after the heater malfunctions, has been dropped or damaged in any manner.

If the supply cord is damaged, it must be replaced by the manufacturer, it's service agent or similarly qualified persons in order to avoid a hazard.

Do not remove this Installation & Service Manual or the provided spanners from the site of installation. Ensure that the manual is stored safely for future reference.

Chemical Burn and Choking Hazard!

Keep batteries away from children.

This product contains two AAA batteries. If a new or used AAA battery is swallowed it can cause severe internal burns and can lead to death in as little as 2 hours. Always completely secure the battery compartment. If the battery compartment does not close securely, stop using the product, remove the batteries, and keep it away from children. If you think batteries might have been swallowed seek immediate medical attention.

SAVE THESE INSTRUCTIONS

INTRODUCTION

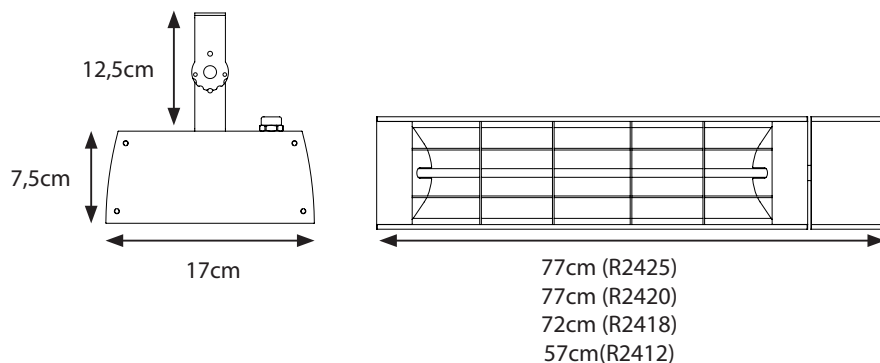

PRODUCT FEATURES

The NEVADA carbon infrared heater is engineered as a robust outdoor heater. Every component in the NEVADA heater is optimized for performance. That includes the veito carbon infrared tube producing mid-wave infrared heat. The NEVADA heater has weatherproof design, which means you can use it for patios, terraces, smoking areas, conservatories, restaurants, hotels, garages, workshops, factories, warehouses and many more.

PRODUCT SPECIFICATIONS

	NEVADA			
MODEL	R2425	R2420	R2418	R2412
VOLTAGE	220-240V 50/60Hz	220-240V 50/60Hz	220-240V 50/60Hz	220-240V 50/60Hz
POWER	2100-2500W	1700-2000W	1400-1700W	1000-1200W
WEIGHT	2,8 KG	2,8 KG	2,7 KG	2,4 KG
IP RATING	IP55			

INSTALLATION

Installation must be carried out by a licensed and authorised person only.

Never attempt to carry out an installation while the electrical power is switched on.

Remove all protective plastic from the heater before installation.

Ensure that you refer to the installation precautions under **IMPORTANT SAFETY INSTRUCTIONS** before starting to mount the heater.

Only connect the appliance to a power supply that conforms to the specification stated on rating plate.

Use only wall outlets approved for outdoor use with a minimum of IP44.

For installation use only the supplied accessories or original accessories approved by the manufacturer.

This heater must be installed according to the minimum installation clearances shown in the diagrams.

A minimum safety distance of 150cm should always be left in front of the appliance.

This heater must be mounted at a minimum of 180cm above the floor.

The heater should always have a minimum clearance of 50cm from a ceiling and adjacent walls.

Mark and drill the mounting holes on the wall. Attach the mounting bracket to the wall.

Bring the heater up to mounting bracket. Insert M6 bolts in the slots on the bracket. Lock into position with M6 nuts.

Rotate the heater to require angle and lock into position with the bolt and nut on the wall bracket.

Do not position the heater on the wall at an angle of less than 45°.

Do not place articles on or against this appliance.

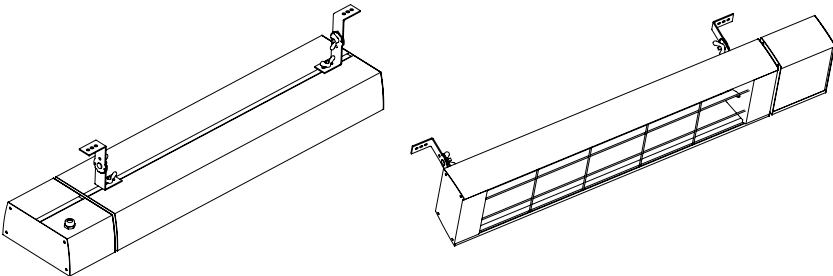

WALL

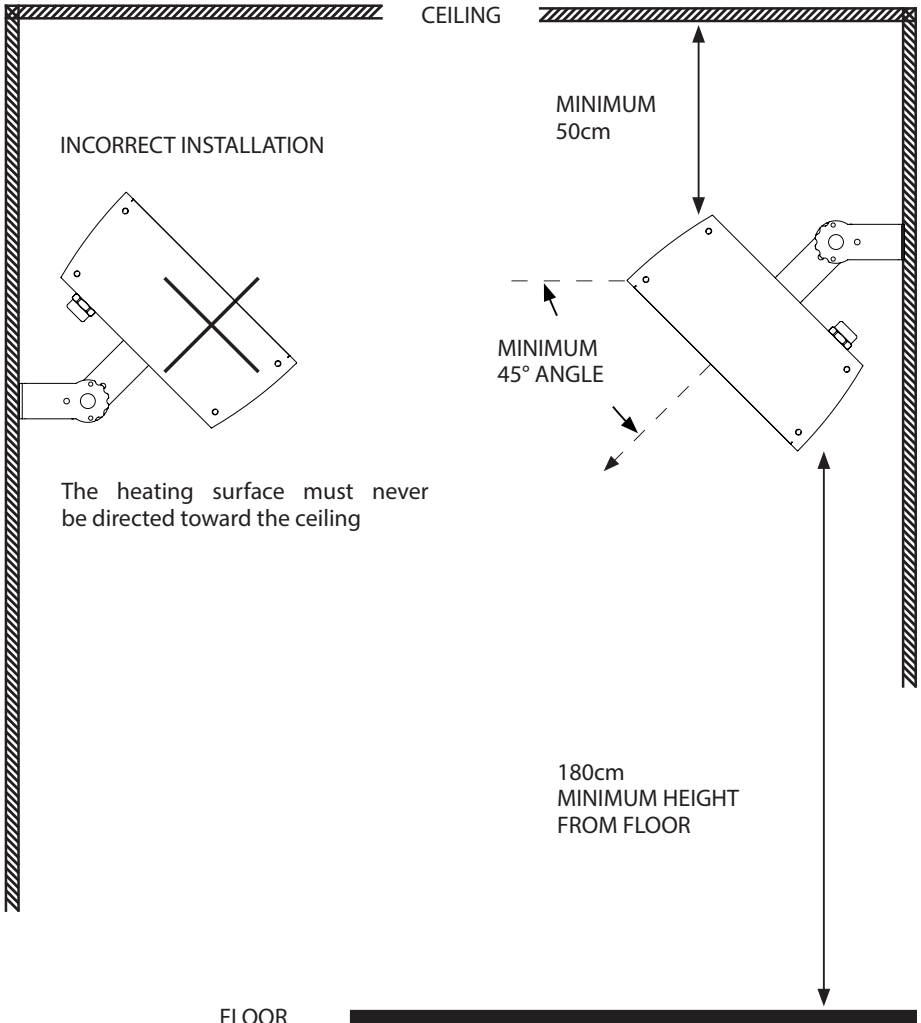
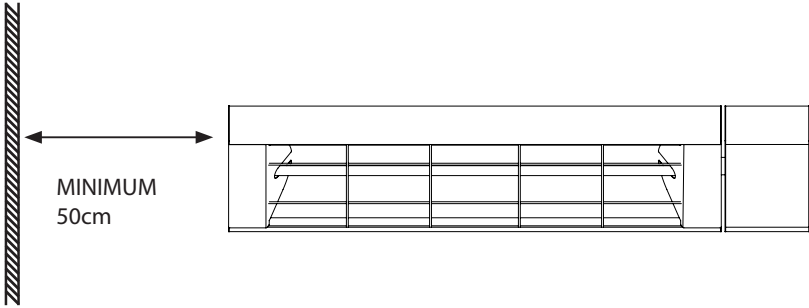

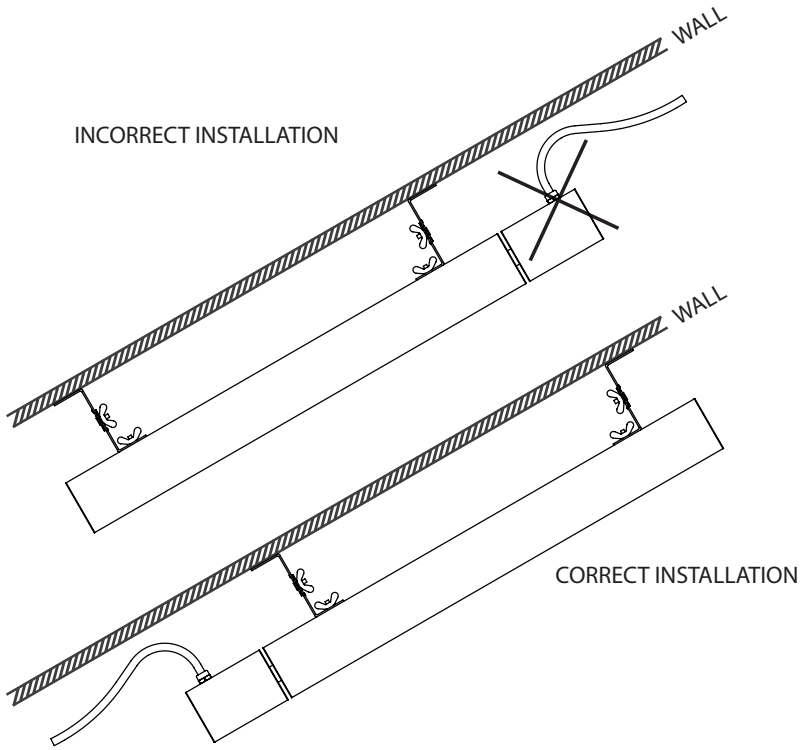





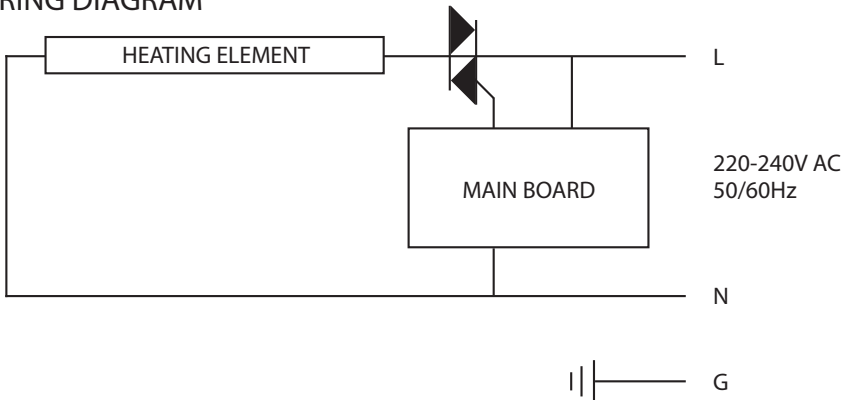

The supply cable must be at the lower end of the heater if the heater is installed at an angle or vertically.

WIRING DIAGRAM



OPERATION

-  Press the button to turn on the heater at high level.
-  Press the button to turn on the heater at low level.
-  Press the button to set the required room temperature. The heater will adjust the level when the temperature set has been reached.
- 
-  Press the button repeatedly to cycle through the sleep time options:
1h – 2h – 3h – 4h – 5h – 6h – 7h – 8h – 9h – OFF
Once the sleep time is expired, the unit will be switched off.
During operation, press the button once to check the remaining sleep time.
-  Press the button to turn the heater off.

You can also use the button on the unit to operate the heater.

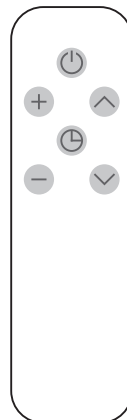

REPLACING REMOTE CONTROL BATTERIES

Replace all two batteries when the remote control stops operating or its range seems reduced.

Slide the battery compartment cover off.

Symbols inside the compartment show how to match the - and + symbols on the batteries.

Insert the two AAA batteries, making sure to match the - and + symbols.

Slide the cover back on until it clicks into place.

Note: Do not allow water or liquid to get into the remote control.

CLEANING AND MAINTENANCE

Always disconnect the heater from the electricity supply and allow adequate time (minimum of 30 mins.) for it to cool before adjusting the position or attempting to work on it.

If the heater has collected dust or dirt inside the unit or around the heating element, have the unit cleaned by a qualified service agent. Do not operate the heater in this condition.

The only maintenance required is cleaning of the external surfaces of the heater.

Do not use powerful abrasive or solvent cleaning fluids when cleaning the heater. Use a damp cloth to wipe the outside of the heater. If removed from its mounting position when not in use, store the heater carefully in a safe, dry, childproof location.

Do not touch the heating element with bare fingers, as residue from your hand could affect the life of the lamp. If it is accidentally touched, remove the finger marks with a soft cloth moistened with methylated spirit or alcohol.

Do not attempt to repair or adjust any electrical or mechanical functions on this heater.

The heater contains no user serviceable parts. Check for damage to the appliance regularly. If damage to the appliance is suspected, discontinue use immediately and contact the supplier or qualified person to repair.

PRODUCT DISPOSAL

For the product sold within the European Community. At the end of the electrical products useful life it should not be disposed of household waste. please recycle where facilities exist. Check with your Local Authority or retailer for recycling advice in your country.



